

6.091

Hands-On Introduction to EE Lab Skills

“You chose wisely....”

Instructor: Gim Hom

Lab Assistants: Ben Gelb, Danh Vo

6.091 Course

- Day 1
 - Electronic Components (RLC, diodes) and Theory
 - Use of Multi-Meters & Oscilloscopes; Construction & Debugging of Simple Electronic Circuits
- Day 2 LED's, BJT, MOSFETS, Optical Isolators, Op Amps
- Day 3: More Integrated Circuits: Timers, Voltage Regulators, Simple Power Amplifier
- Day 4: Motors, Digital ICs
- Day 5: AD/DA Converters, Digital Design Lab, Wrap Up
- 6 Unit; course grading is pass/fail. Completion of all 5 labs required for passing.

Course Schedule

- Lectures Jan 14, 16, 22, 24, 29
- Lab hours – 3 Sections
Section 1: 5-9PM; Section 2: 2-6PM, Section 7-11PM

M	T	W	R	F
14 Lecture Sec 1 Lab	15 Sec 2 Lab Sec 3 Lab	16 Lecture Sec 1 Lab	17 Sec 2 Lab Sec 3 Lab	18
21	22 Lecture Sec 1 Lab	23 Sec 2 Lab Sec 3 Lab	24 Lecture Sec 1 Lab	25
28 Sec 2 Lab Sec 3 Lab	29 Lecture Sec 1 Lab	30 Sec 2 Lab Sec 3 Lab	31	

Safety

- 5-10 ma can cause death
- Skin resistance can range from 1k for wet skin to 500k for dry skin.
- Death can result from as low as 50 volts
- Body can sense 9 volts under the right conditions.

Electrical Units

- Voltage: volts ($\mu\text{v} \rightarrow \text{kv}$)
- Current: amperes (amps), milliampere ($\text{ma } 10^{-3}$)
- Resistance: ohms Ω , k-ohms ($\text{k } 10^3$), meg ohms ($\text{m } 10^6$)
- Capacitance: farad, microfarad ($\mu\text{f } 10^{-6}$), nanofarad ($\text{nf } 10^{-9}$), picofarad ($\text{pf } 10^{-12}$)
- Inductance: henry, millihenry, microhenry
- Frequency: mhz, ghz 10^9

Common Acronyms

- BJT – Bipolar Junction Transistor
- MOSFET – Metal Oxide Field Effect Transistor
- PCB – Printed Circuit Board
- DIP – dual inline package
- SMD, SMT Surface mount device/technology
- cap – capacitor
- pot – potentiometer
- AM – amplitude modulation
- FM – frequency modulation
- RF – radio frequency
- IF – intermediate frequency.
- dikes – diagonal pliers
- 1Nxxx diodes
- 2Nxxxx transistors

EE Symbols

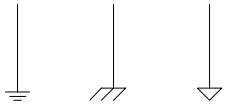

ground

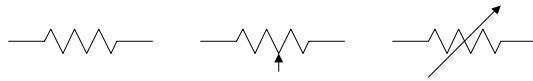

resistor, variable



switches

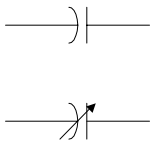

capacitor



Inductor

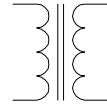

transformer

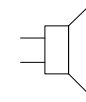

speaker



fuse

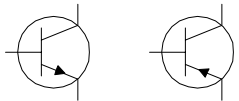

npn, pnp



mosfets

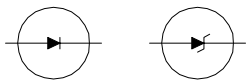

diode, zener diode

Voltage

- What is the equation describing the voltage from a 120VAC outlet?
- 120 VAC is the RMS (Root Mean Square Voltage)
- 60 is the frequency in hz
- Peak to peak voltage for 120VAC is 340 volts!

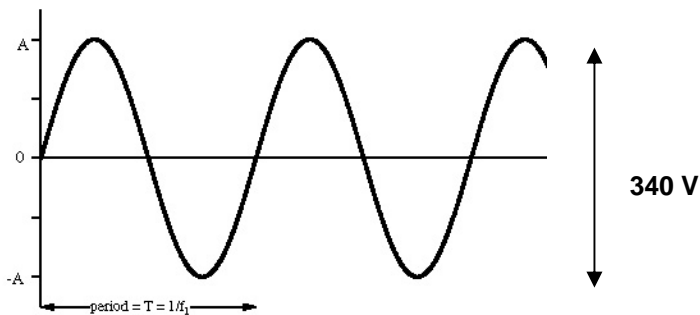

RMS Voltage

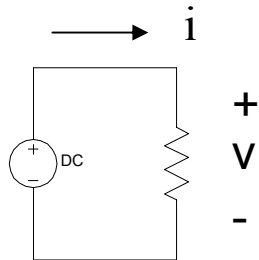
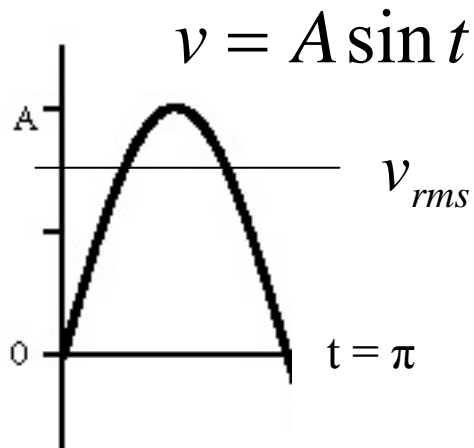

- The RMS voltage for a sinusoid is that value which will produce the same heating effect (energy) as an equivalent DC voltage.

- Energy = $\int P dt = \int v i dt = \frac{1}{r} \int_0^{\pi} v^2 dt$

- For DC, $\frac{v_{rms}^2 \times \pi}{r}$

- Equating and solving, $A = \sqrt{2} v_{rms}$

RMS Derivation

$$\frac{v_{rms}^2 \times \pi}{r} = \frac{1}{r} \int_0^{\pi} v^2 dt = \frac{1}{r} \int_0^{\pi} A^2 \sin^2 t dt$$

$$\int_0^{\pi} \sin^2 t dt = \left[\frac{t}{2} - \frac{1}{4} \sin 2t \right]_0^{\pi}$$

$$\frac{v_{rms}^2 \pi}{r} = \frac{A^2}{r} \left[\frac{t}{2} - \frac{1}{4} \sin 2t \right]_0^{\pi}$$

$$A = \sqrt{2} v_{rms}$$

Resistors

- $V = IR$
- Resistor parameters: resistance, tolerance and power rating.
- Variable resistors: pots
- Resistors are color coded
- **Standard Values 10 12 15 18 22 27 33 39 47 56 68 82**
- Common tolerance: $\pm 5\%$, $\pm 1\%$,
- Series/parallel combination
- Why is high voltage used in power lines?

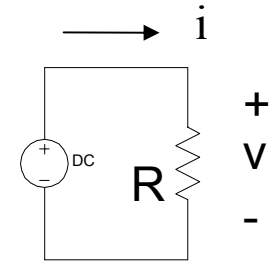

Resistor Color Code

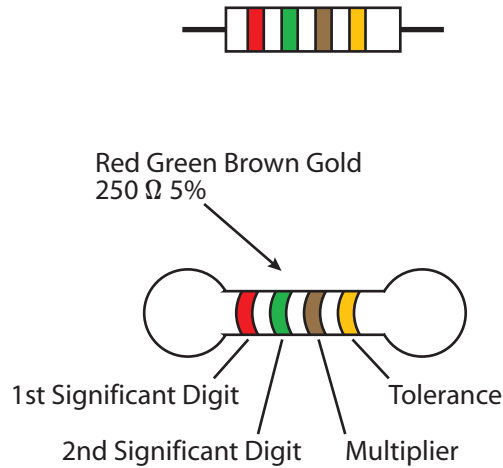

Color	1st-band Digit	2nd-band Digit	3rd-band Digit	4th-band Digit
Black	0	0	$10^0 - 1$	
Brown	1	1	$10^1 - 10$	1%
Red	2	2	$10^2 - 100$	2%
Orange	3	3	$10^3 - 1000$	3%
Yellow	4	4	$10^4 - 10000$	4%
Green	5	5	$10^5 - 100000$	
Blue	6	6	$10^6 - 1000000$	
Violet	7	7	$10^7 - 10000000$	
Gray	0	0	$10^8 - 100000000$	
White	9	9	$10^9 - 1000000000$	
Gold				5%
Silver				10%
None				20%

Figure by MIT OpenCourseWare.

red green brown gold
250 Ω 5%

2%, 1% Resistor Codes

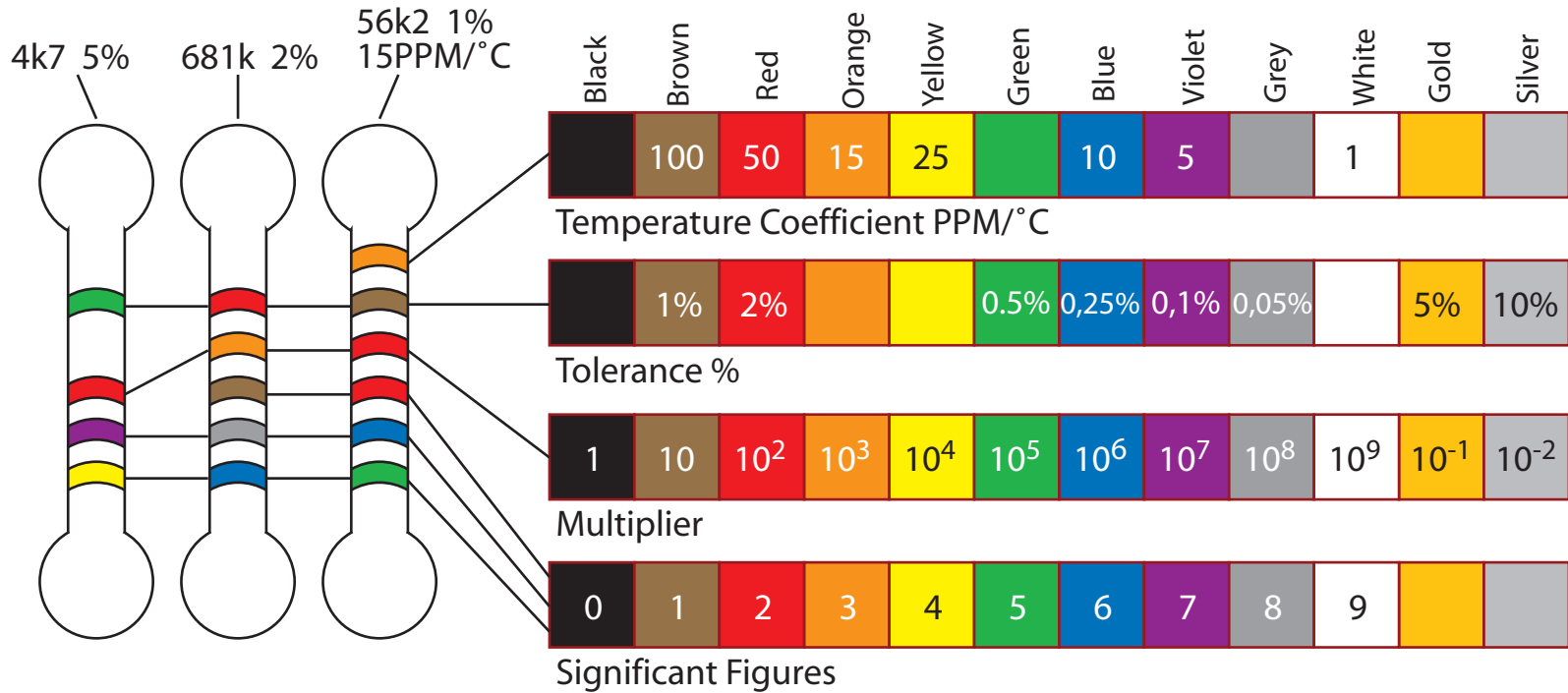
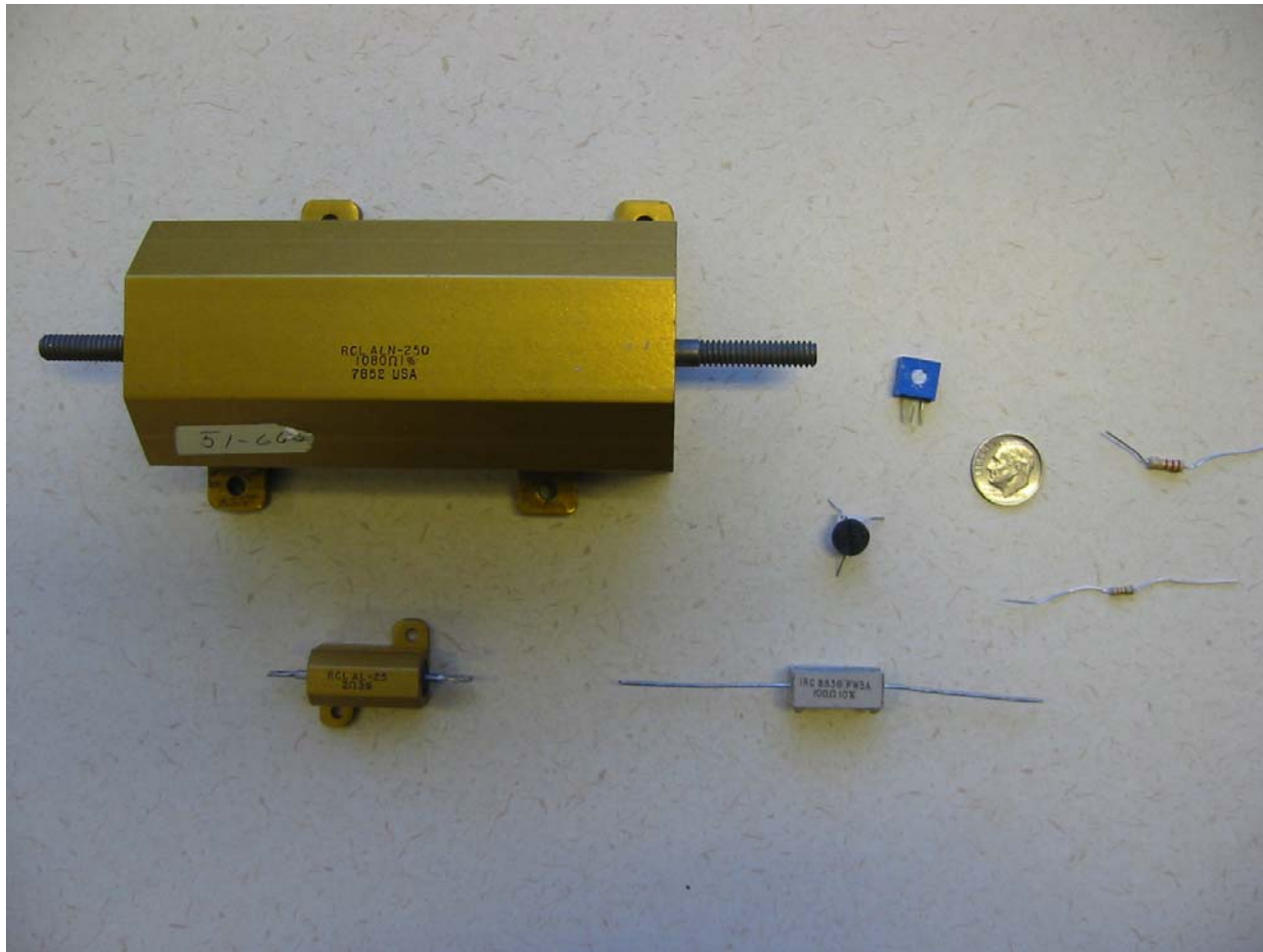
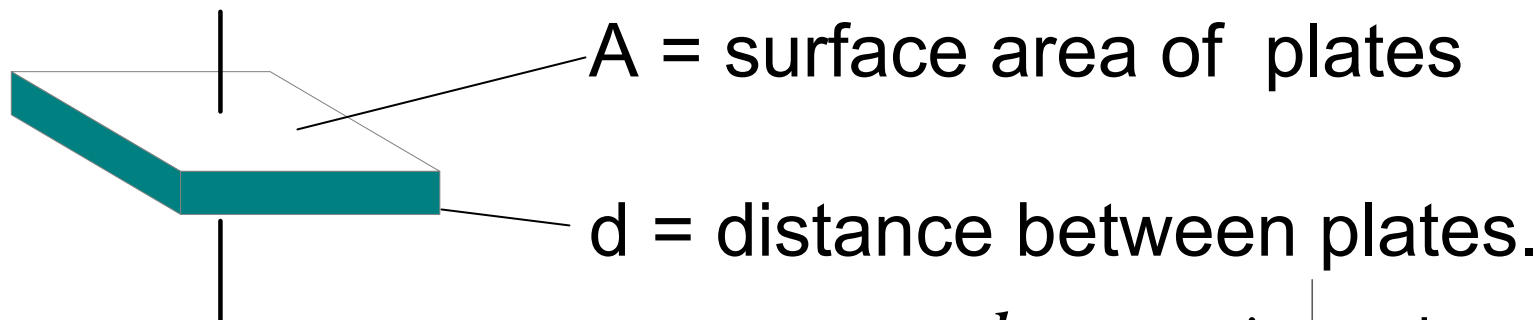

Figure by MIT OpenCourseWare.

Resistors



Capacitance



$$C = \frac{K\epsilon_0 A}{d} \quad i = C \frac{dv}{dt}$$

A circuit symbol for a capacitor, consisting of two parallel lines. To the left of the symbol is a downward-pointing arrow labeled 'i', representing current. To the right of the symbol is a vertical line with a '+' sign at the top and a '-' sign at the bottom, representing voltage 'v'.

Standard Capacitance Values: 10 12 15 18 22
27 33 39 47 56 68 82

Examples: 100pf, 180pf, 270pf,... 1 μ f , 2.2 μ f , 4.7 μ f ,...

Capacitor marking: 104 = 10×10^4 pf = $10^5 \times 10^{-12}$ f = 10^{-7} f = 0.1 μ f

Capacitors

- Parallel / Series combination
Think!

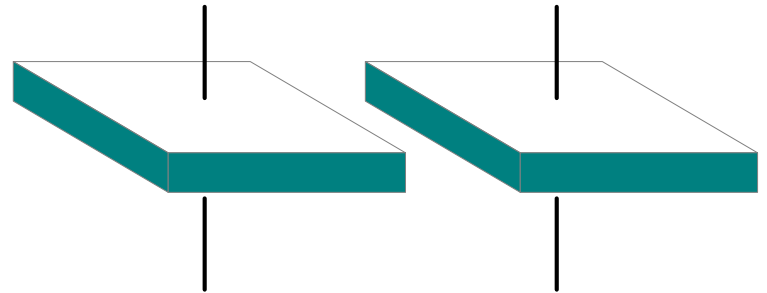

- Capacitors range for 1 pf (10^{-12}) to 100,000 μf (10^{-1})
- Typically capacitors larger than $1\mu\text{f}$ are polarized. Non polarized units are marked NP (non-polar) or BP (bipolar).
- All capacitors have maximum voltage ratings.

Capacitors



Inductors

$$v(t) = L \frac{d}{dt} i(t)$$

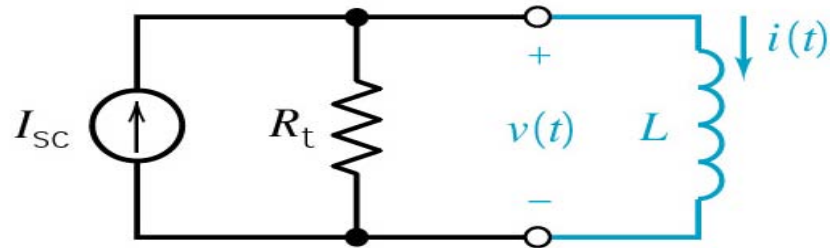

- Inductors are used in tuned circuits, switching power supplies, voltage converters, light dimmers, GFI.
- Inductors vary from a few μh (etched on a pcb) to henries.

Inductors

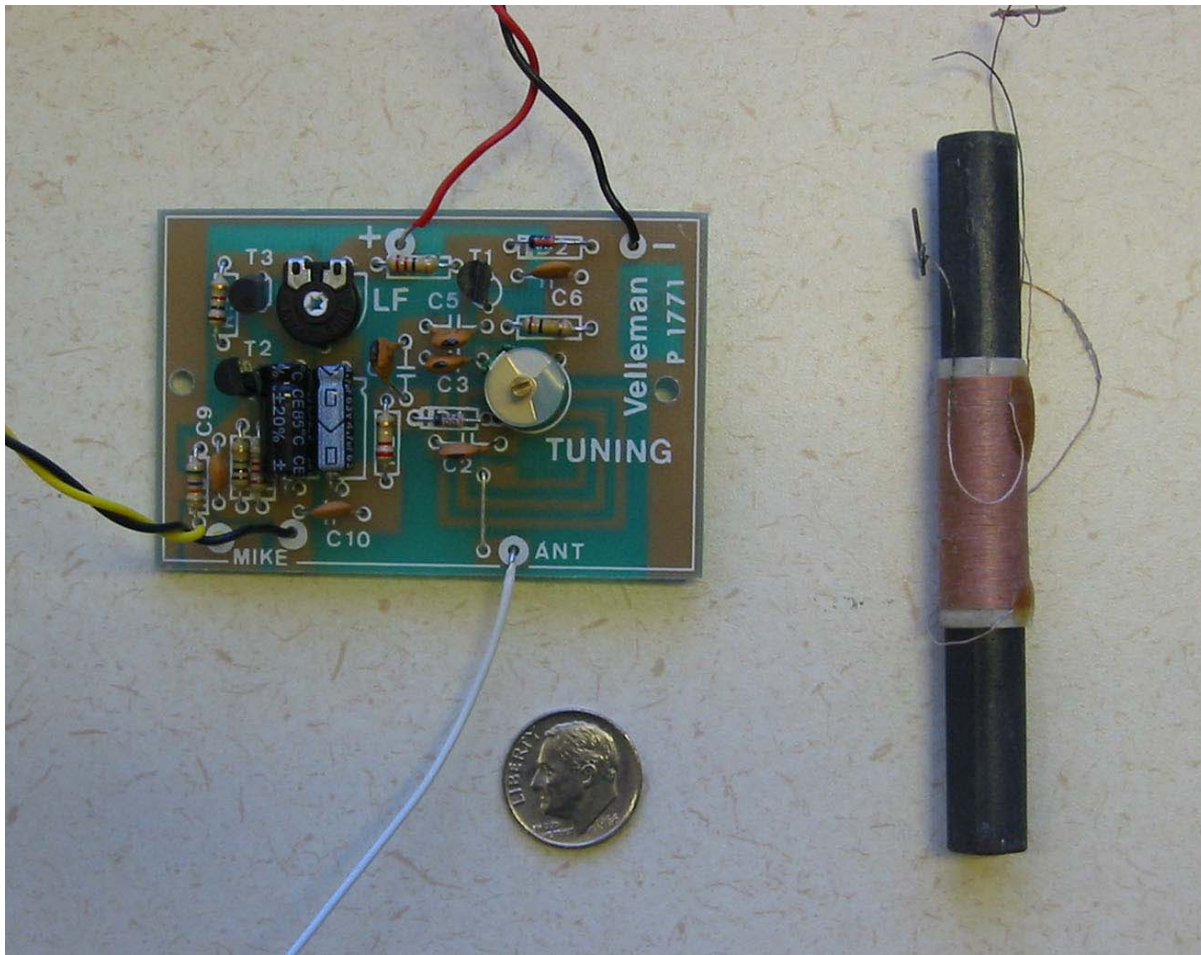

Diodes

- Diodes allow current to flow in the direction of the arrow.
- Can be modeled as an open circuit in one direction and a short circuit in the other (with a 0.6 volt drop)
- Diode parameters: max current, reverse breakdown voltage, reverse recovery time.

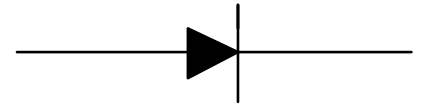

Lab 1

- Display signals on scope
- Measure the time, frequency, and voltage with oscilloscope – manually and scope assisted.
- Voltage measurement across resistor divider
- Build simple circuits on a protoboard.
- Solder a resistor cube and measure resistance between opposite corners.
- Return only the switches.

Proto-Boards

- +5v, +15v, -15v available
- Pins within row or column connected
- Wiring convention:
 - red: positive
 - black: ground (reference point) or negative

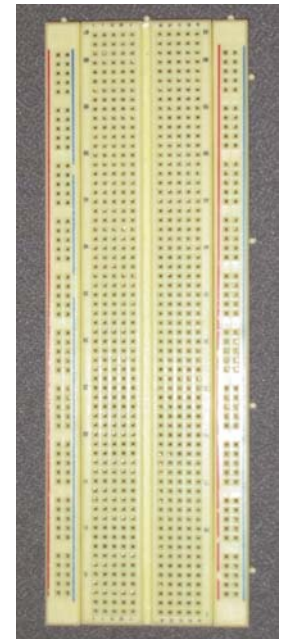
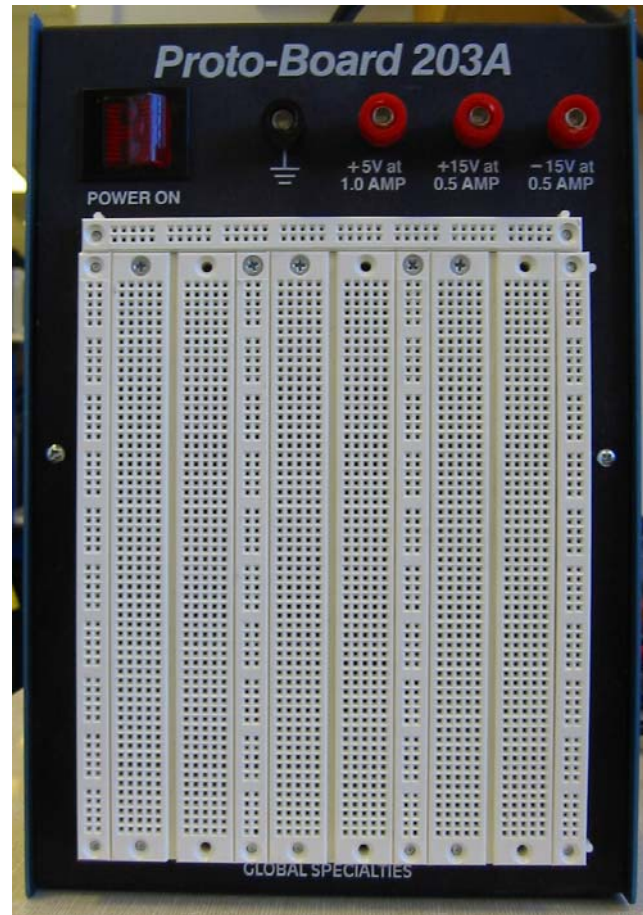

Lab Instruments

- Function Generator – generate modulated or unmodulated waveform.
- DMM – digital multimeter; measures voltage, current and resistance
- Oscilloscope – displays waveforms x-axis = time; y axis = amplitude

Agilent Function Generator



Agilent DMM



Oscilloscope

Cursor controls

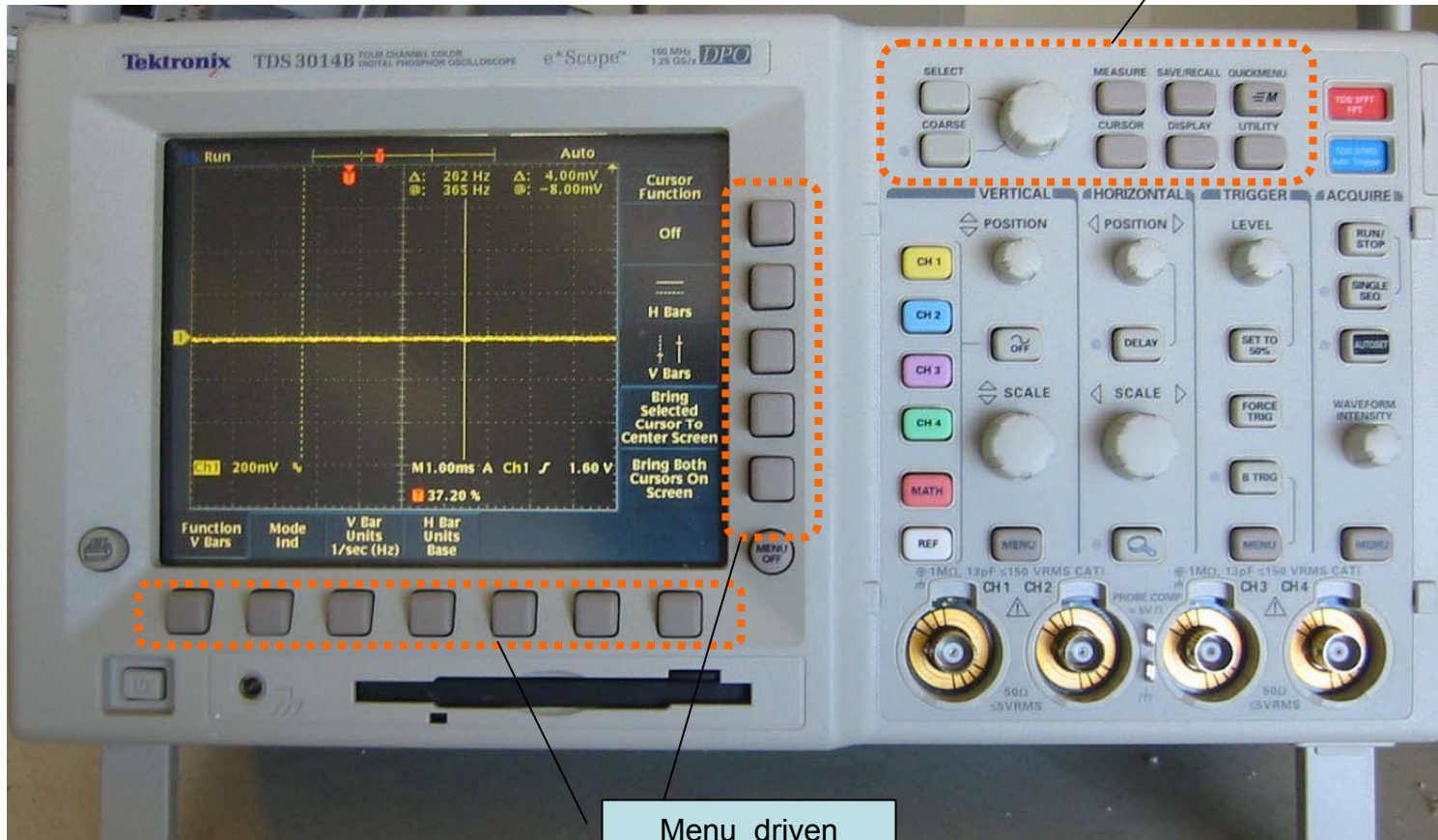

Menu driven soft key/buttons

Oscilloscope Controls

- Auto Set, soft menu keys
- Trigger
 - channel,
 - slope,
 - Level
- Input
 - AC, DC coupling,
 - 10x probe,
 - 1khz calibration source,
 - probe calibration,
 - bandwidth filter
- Signal measurement
 - time,
 - frequency,
 - voltage
 - cursors
 - single sweep
- Image capture

Personal DMM

- Voltage DC: 2mv-1000v
- Voltage AC: 2vac-750vac
- Current: 2ua-10A
- Resistance: 2-2m
- BJT: beta test
- Diode test



Soldering Technique

- Use ceramic tile.
- Turn on soldering iron.
- Clean tip on wet sponge.
- Apply heat to circuit board and/or component.
- Apply solder to the component (not the soldering iron). Let the component melt the solder!

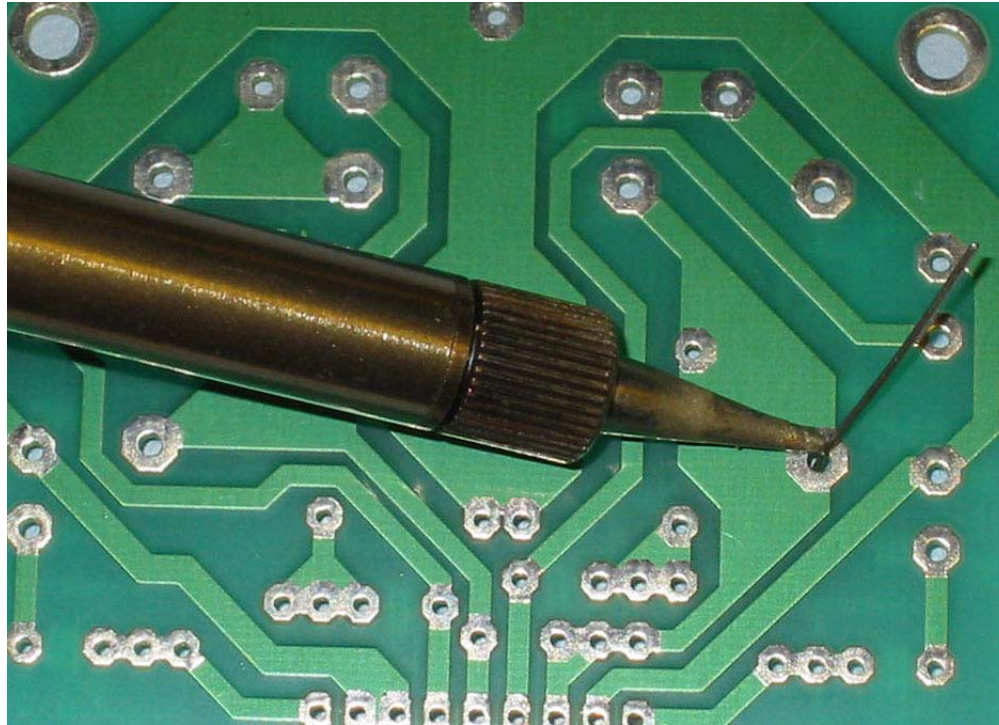

Apply heat to the circuit board

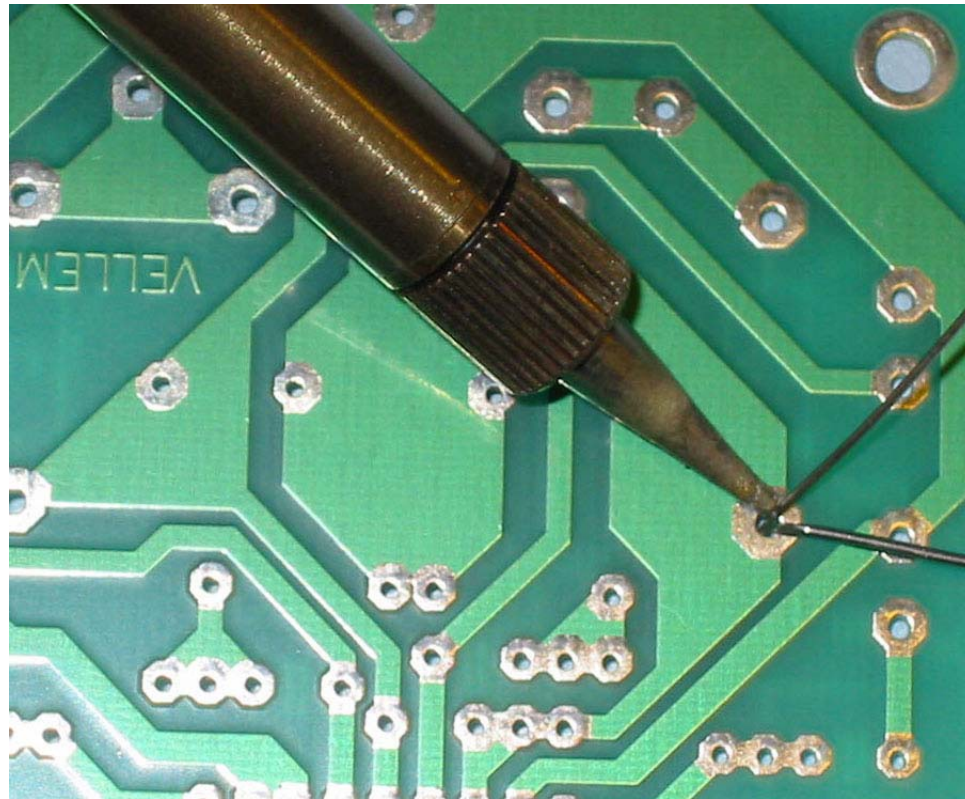

Apply solder to the component, not to the soldering iron

Resistor Cube

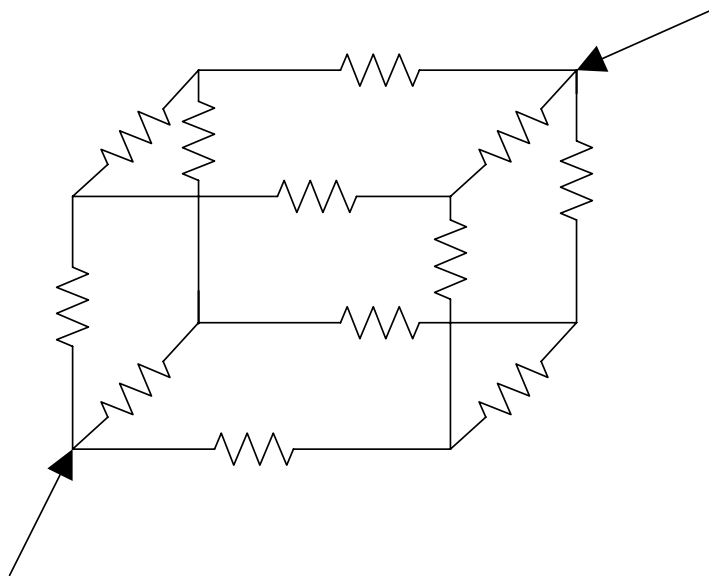

Build and solder a resistor cube with (12) 1k resistors.

What is the resistance between the two points?